

Feature:



- High quality 2835 SMD LED.
- Calendaring copper processing for FPC, more stronger and reliable.
- Uniform lighting, dot free.
- Good flexibility and can be adapted to different application shapes.
- Excellent weather and corrosion resistance.

Technical Specifications:				Symbol	CCT	Flux Lm/m
Rated Power	12W/m	Control	/	●	2700K	435
Rated Voltage	DC24V	Pixel	/	●	3000K	485
LED Qty.	140LED/m			●	4000K	540
LED Package	SMD2835			●	5000K	567
Colour/Ra	Ra>80			●	6500K	620
Beam Angle	120°			●	Red	
SDCM	/			●	Green	
Operating Temp.	-20~45°C			●	Blue	
Storage Temp.	-25~60°C			●	RGB/RGBW	
Lifespan	>30, 000h					
International Protection	IP67					
Inverse Kinematics	/					

※The above power lumen data is based on the measurement results when the product length is 1 meter and the color temperature is 4000K, with a measurement deviation of ±10%.

Product Size:

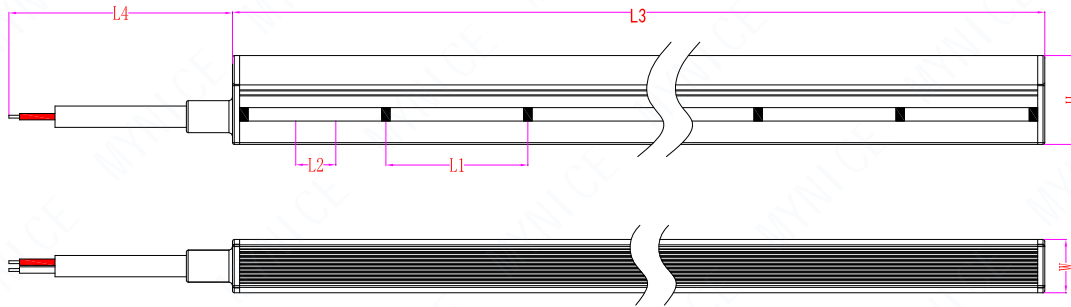

						Units: mm	
Code	Cut/L1	Distance/L2	Length/L3	Cable/L4	Width/W	Height/H	
Value	50	7.14	5010	200	12	25	
Tolerance	±1	±0.1	±20	±10	±1	±1	

Waterproof Connector:

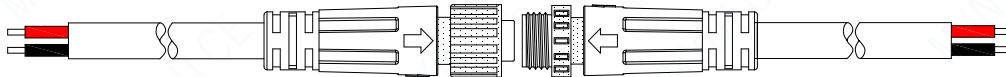

Accessory Information:



Head cap 1pcs/Reel	End Cap 1pcs/Reel	Glue 1pcs/Reel	Clips 3pcs/m	Screw 3pcs/m	Alum. carrier Optional	Mold able carrier Optional
-----------------------	----------------------	-------------------	-----------------	-----------------	---------------------------	----------------------------------

Mounting Dimensions:

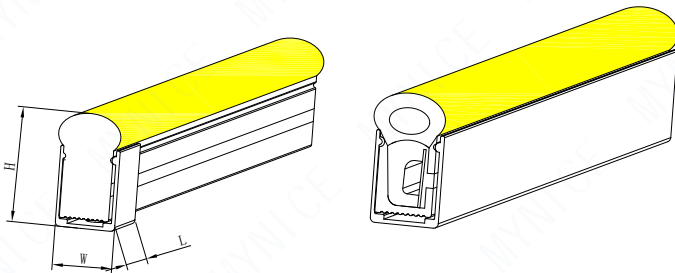

Clips & Alum. Carrier:L20*W14*H19 mm

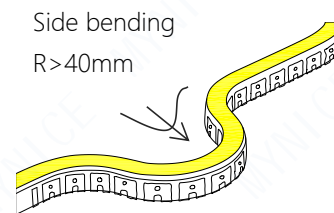

Mold able Carrier

Luminous Intensity Distribution Diagram:

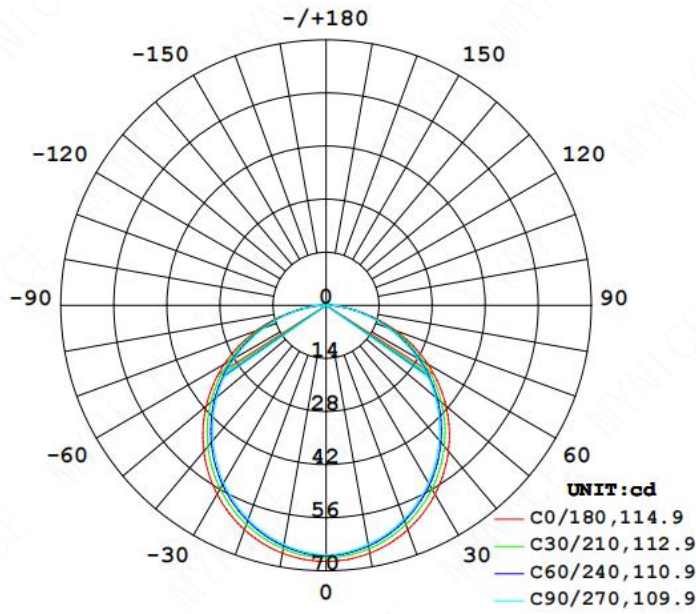

Average Beam Angle(50%):112.1 DEG

Packaging Information :

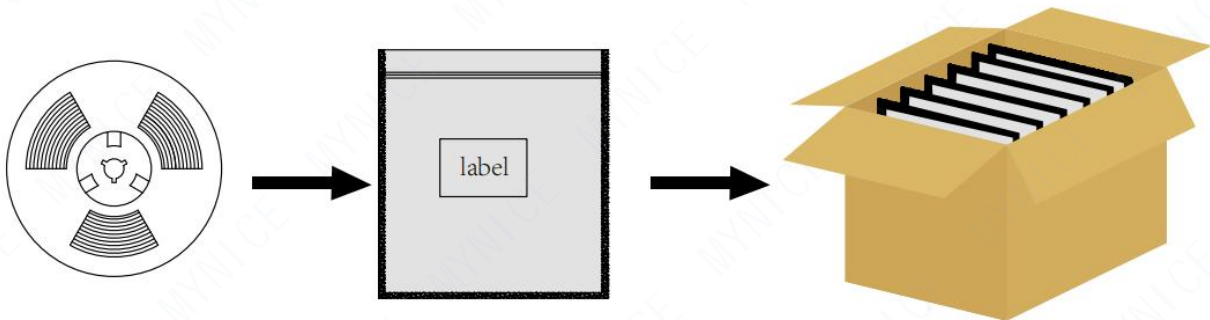

Net weight (g)	Inner box size (cm)/weight (kg)	Qty PCS/CTN	Carton Size(cm)/GW.(kg)
/	/	15pcs	35*25*23cm
/	/	75m	16kg

Electric Diagram:

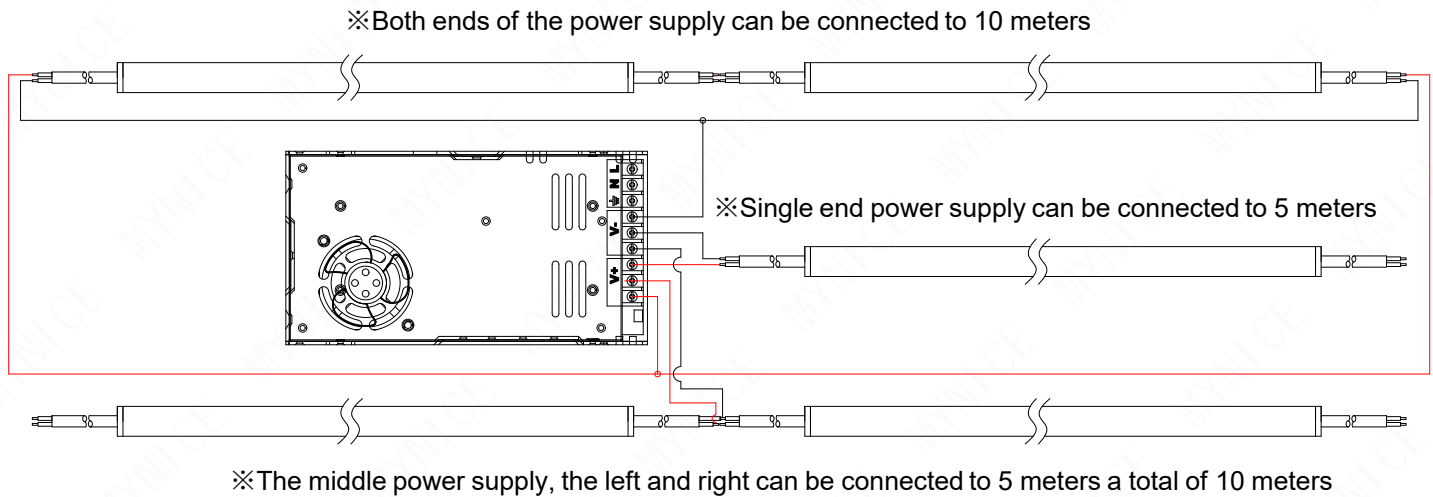

Cautions:

- Installation of LED strip (with power supplies) needs to be made under consideration of all valid regulations and norms.
- Installation by qualified electrician only.
- Please drive the led strip with isolated power, and the ripple of the constant voltage source should be less than 5%.
- Please do not bend the strip into an arc with a diameter less than 40mm to ensure the longevity and reliability.
- Do not fold it in case any damage of LED beads.
- Do not pull the power wire hard to ensure the longevity. Any crash may damage the colloidal surface is prohibited.
- Please make sure the wire is connected to the anode and cathode correctly. The power output should be consistent with the voltage of the strip to avoid damage.
- LED lights should be stored in dry, sealed environment. Please only unpack it before usage. Ambient temperature: -20 °C ~ + 45 °C. Storage temperature: -25 °C ~ + 60 °C/60%RH.
- Please use the strips without waterproof within indoor environment with humidity less than 70%.
- Please be careful during operation. Do not touch the AC power supply in case of electric shock.
- Please leave at least 20% power for the power supply during using to ensure there is enough power supply to drive the product.
- Do not use any acid or alkaline adhesives to fix the product (e.g.: glass cement).
- The joints of extended strips should be deal with waterproof when using waterproof products.